

# Torque Wrench Color Coded Pre-Set Type OPERATION MANUAL

Models covered

**FPS**

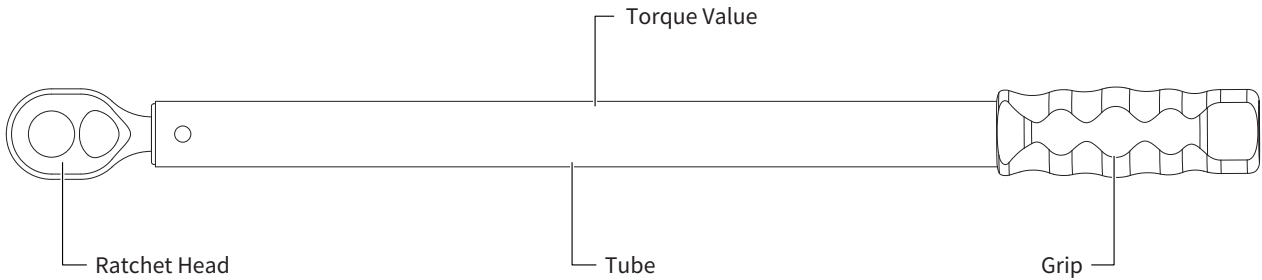

## BEFORE STARTING

1. Study this instruction before use.
2. This torque wrench is calibrated and tested before leaving the factory, it is certified to meet the current standard specification and has an accuracy of  $\pm 4\%$ .
3. **THIS TOOL IS A PRECISION MEASUREMENT AND DESIGNED FOR MANUAL TIGHTENING FASTENERS ONLY. DO NOT USE IT AS A NUT BREAKER OR FOR ANY OTHER PURPOSE.**
4. Do not over torquing the fastener, or it will cause tool's damage and serious injury.
5. Do not use this tool near rotating machinery.
6. Disassemble this tool or make any adjustments will result in the loss of accuracy and invalidating the warranty.
7. Do not continuously apply force after hearing the clicking sound or feel shock.
8. Do not use any kind of extension on the handle of the tool. This will not only damage the tool, also affect the accuracy.
9. Do not immerse grease inside ratchet head. It may cause unexpected damage.
10. Please wear gloves and goggles when working.

## CONTENTS

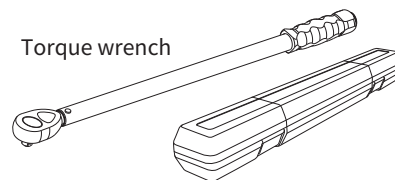

Supplied in a plastic box.



Manual



## HOW TO USE

Insert square drive securely to the socket.

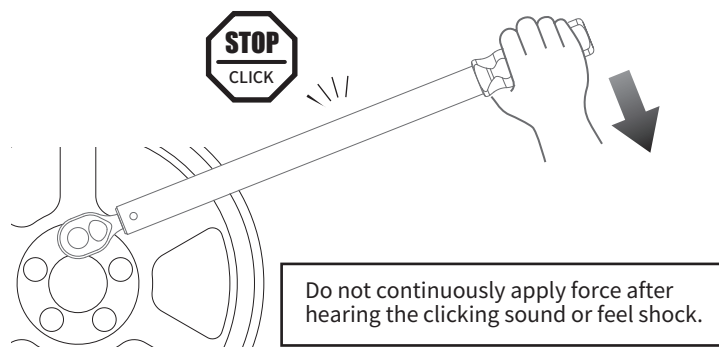
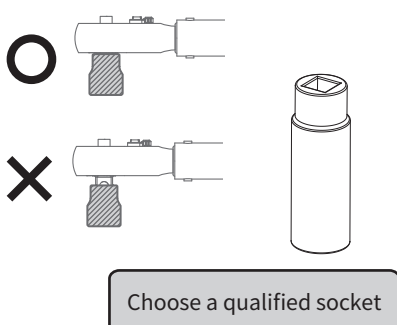

After all the nuts are installed, use a torque wrench to tighten the screws one by one in the order.

4 holes

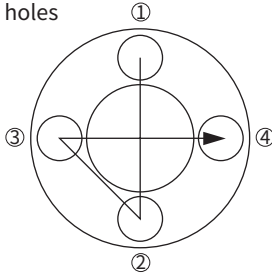

5 holes

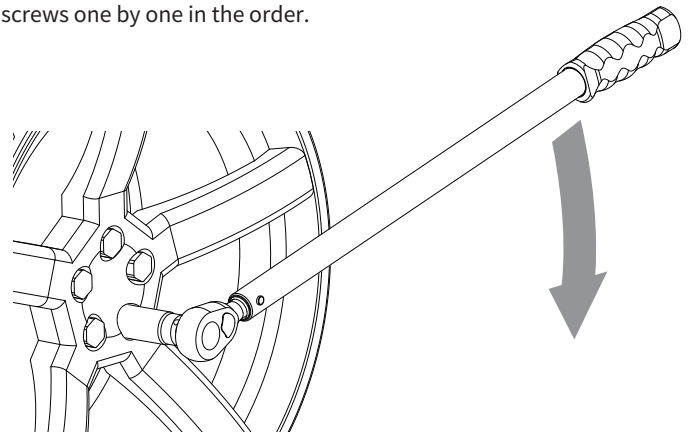
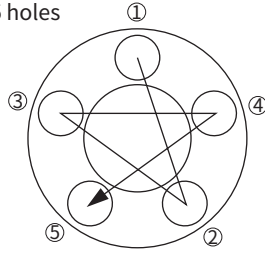

## MAINTENANCE AND STORAGE

1. If this tool has not been used for a period of time, it shall be preloaded several times to allow internal lubricant to recoat.
2. Clean this tool by wiping with a clean cloth after operation and storage in a dry environment. Do not dip any type of liquid in this tool. This may damage the internal of this tool.
3. This tool should be recalibrated a period of 12 months, or 5,000 cycles, whichever occurs first. To contact with local vendor or an authorized repair center for supporting.

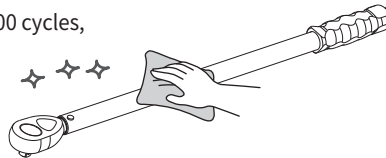

## TORQUE CONVERSION FACTORS

Units to be converted	Corresponding unit								
	=mN·m	=cN·m	=N·m	=ozf·in	=lbf·in	=lbf·ft	=gf·cm	=kgf·cm (kp·cm)	=kgf·m (kp·m)
1 mN·m	1	0.1	0.001	0.142	0.009	0.0007	10.2	0.01	0.0001
1 cN·m	10	1	0.01	1.416	0.088	0.007	102	0.102	0.001
1 N·m	1000	100	1	141.6	8.851	0.738	10197	10.2	0.102
1 ozf·in	7.062	0.706	0.007	1	0.0625	0.005	72	0.072	0.0007
1 lbf·in	113	11.3	0.113	16	1	0.083	1152.1	1.152	0.0115
1 lbf·ft	1356	135.6	1.356	192	12	1	13826	13.83	0.138
1 gf·cm	0.098	0.01	0.0001	0.014	0.0009	0.00007	1	0.001	0.00001
1 kgf·cm(kp·cm)	98.07	9.807	0.098	13.89	0.868	0.072	1000	1	0.01
1 kgf·m(kp·m)	9807	980.7	9.807	1389	86.8	7.233	100000	100	1

Conversion-formula :  
 Units to be converted × Factor = Corresponding unit  
 Example : Convert 5 lbf·ft into cN·m  
 Solution : 5 × 135.6 = 678 cN·m

## SPECIFICATION

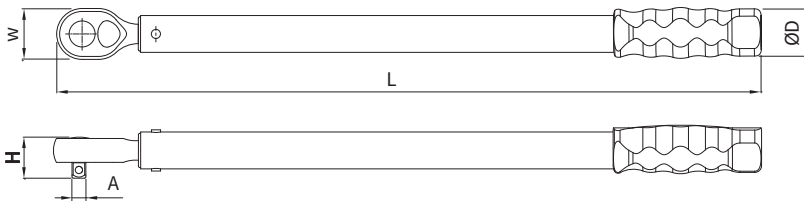

Accuracy : ± 4%

ITEM NO.	⊙ A	Range		W	H	L	∅D	KG	Color
FPS-65F	1/2"	88 Nm	65 ft.lb	43.5	36.5	588	37.3	1.6	Yellow
FPS-80F	1/2"	108 Nm	80 ft.lb	43.5	36.5	588	37.3	1.6	Blue
FPS-100F	1/2"	135 Nm	100 ft.lb	43.5	36.5	588	37.3	1.6	Gray
FPS-120F	1/2"	163 Nm	120 ft.lb	43.5	36.5	588	37.3	1.6	White
FPS-140F	1/2"	190 Nm	140 ft.lb	43.5	36.5	588	37.3	1.6	Light Green

Unit : mm

Version 03

Jun. 2023



**MATATAKITOYO**  
**TORQUE TOOLS**  
 E-mail: matatakitoyo@gmail.com  
 www.matatakitoyo.com

Manufacturer  
**MATATAKITOYO TOOL CO., LTD.**  
 No. 63, Ln. 493, Sec. 3, Zhongshan Rd., Tanzi Dist.,  
 Taichung City 42754, Taiwan  
 TEL : 886-4-2533 5893

Made in Taiwan